

CALAIS COLLECTION

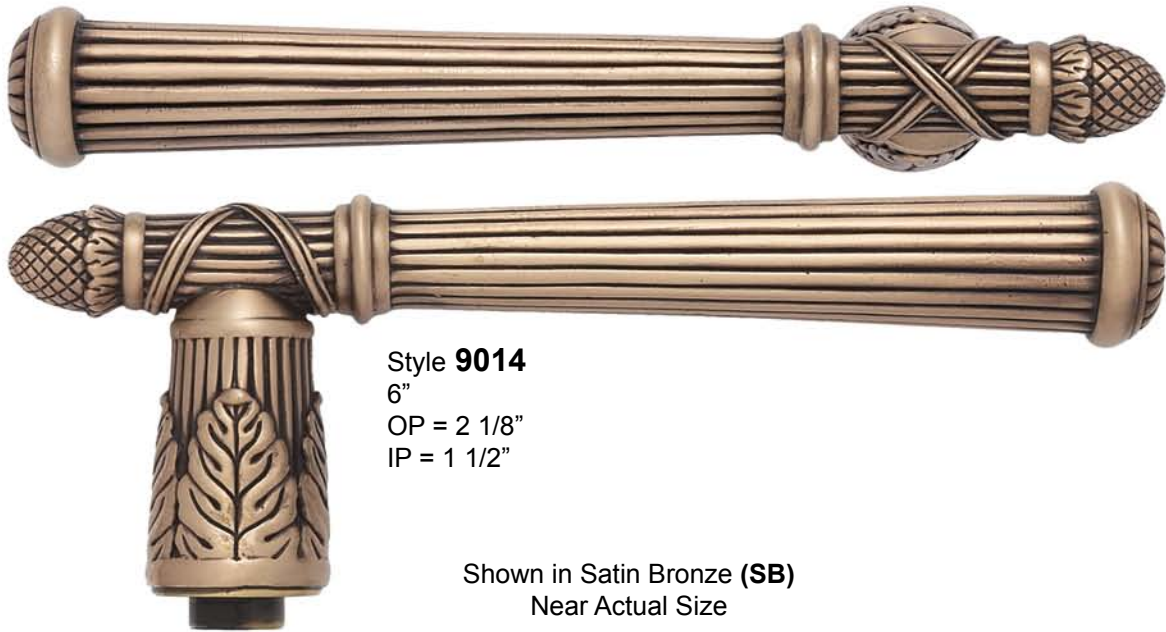



Style **9014**  
6"  
OP = 2 1/8"  
IP = 1 1/2"

Shown in Satin Bronze (SB)  
Near Actual Size



Passage Set  
7.25mm on the Diamond  
**9014/77** + Finish

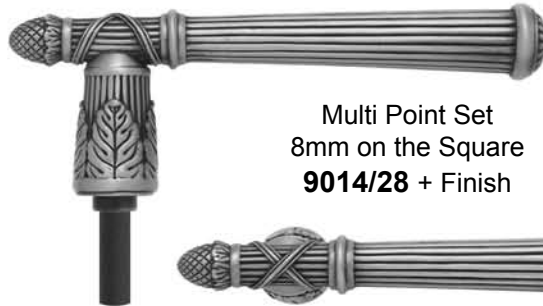

Left Hand Exterior

Multi Point Set  
8mm on the Square  
**9014/28** + Finish



Right Hand Interior



Single Left Hand Passage  
**9014/71** + Finish



Right Hand Exterior

Multi Point Set  
8mm on the Square  
**9014/82** + Finish



Single Right Hand Passage  
**9014/17** + Finish



Left Hand Interior



Style **9066**  
L = 5 1/8"  
OP = 1 9/16"



Shown in Satin Bronze (**SB**)  
Near Actual Size

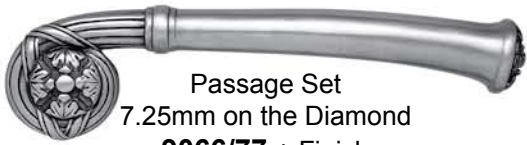

Passage Set  
7.25mm on the Diamond  
**9066/77** + Finish

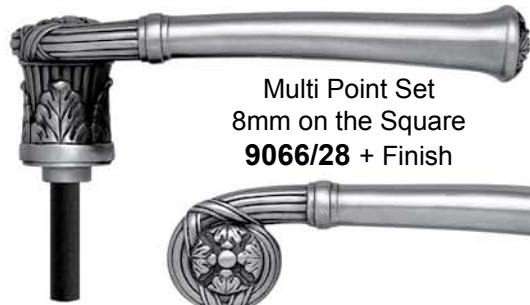

Left Hand Exterior

Multi Point Set  
8mm on the Square  
**9066/28** + Finish



Right Hand Interior



Single Left Hand Passage  
**9066/71** + Finish



Single Right Hand Passage  
**9066/17** + Finish



Right Hand Exterior

Multi Point Set  
8mm on the Square  
**9066/82** + Finish



Left Hand Interior



Style **9004**  
2 11/16" X 2"  
OP = 2"



Shown in Satin Bronze (**SB**)  
Near Actual Size



Entry Door Set  
8mm on the Square  
**9004/88** + Finish



Passage Set  
7.25mm on the Diamond  
**9004/77** + Finish



Entry - Interior Single  
8mm on the Square  
**9004/18** + Finish

Entry - Exterior Single  
with attached 8mm Spindle  
**9004/28** + Finish



Passage Single  
7.25mm on the Diamond  
**9004/17** + Finish



Style **9153**  
 Dia = 2 9/16"  
 OP = 2 1/16"



Shown in Satin Bronze (**SB**)  
 Near Actual Size



Entry Door Set  
 8mm on the Square  
**9153/88** + Finish



Passage Set  
 7.25mm on the Diamond  
**9153/77** + Finish



Entry - Interior Single  
 8mm on the Square  
**9153/18** + Finish



Entry - Exterior Single  
 with attached 8mm Spindle  
**9153/28** + Finish



Passage Single  
 7.25mm on the Diamond  
**9153/17** + Finish



Style **9015**  
 6 1/16" X 2 5/16"  
 Custom Drill Only  
 Shown in Satin Bronze (**SB**)  
 Near Actual Size

See Universal Thumb Turns



Passage Trim Set **9015/521** + Finish  
 Dummy Set **9015/522** + Finish  
 Trim w/ S Plate **9015/523** + Finish + Hand  
 Trim/Mortise/S Plate **9015/524** + Finish + Hand



Passage Trim Single **9015/511** + Finish  
 Dummy Single **9015/512** + Finish  
 Trim w/ S Plate **9015/513** + Finish + Hand  
 Trim/Mortise/S Plate **9015/514** + Finish + Hand

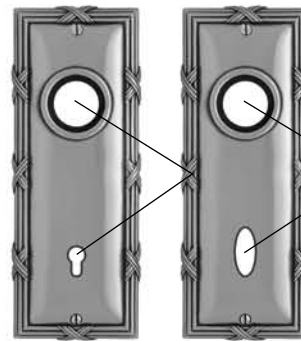

Privacy Trim Set **9015/621** + Finish  
 Trim w/ S Plate **9015/623** + Finish + Hand  
 Trim/Mortise/S Plate **9015/624** + Finish + Hand

On Actual Piece  
 the Spacing is  
 2 7/8" Center to Center

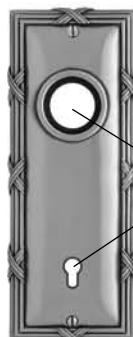

On Actual Piece  
 the Spacing is  
 2 7/8" Center to Center

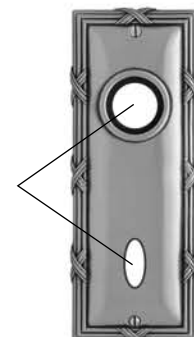

Trim Keyhole **9015/711** + Finish  
 Trim w/ S Plate **9015/713** + Finish + Hand  
 Trim/Mortise/S Plate **9015/714** + Finish + Hand

Trim T/Turn **9015/811** + Finish  
 Trim w/ S Plate **9015/813** + Finish + Hand  
 Trim/Mortise/S Plate **9015/814** + Finish + Hand



Style **9227**  
 2 9/16" X 2 5/16"  
 Custom Drill Only



Shown in  
 Satin Bronze (**SB**)  
 Near Actual Size



Passage Trim Set **9227/521** + Finish  
 Dummy Set **9227/522** + Finish  
 Trim w/Passage S Plate **9227/523** + Finish + Hand  
 Trim/Passage Mortise/S Plate **9227/524** + Finish + Hand  
 Trim/Privacy S Plate **9227/525** + Finish + Hand  
 Trim/Privacy Mortise/S Plate **9227/526** + Finish + Hand

Passage Trim Single **9227/511** + Finish  
 Dummy Single **9227/512** + Finish  
 Trim/Passage S Plate **9227/513** + Finish + Hand  
 Trim/Passage Mortise/S Plate **9227/514** + Finish + Hand  
 Trim/Privacy S Plate **9227/515** + Finish + Hand  
 Trim/Privacy Mortise/S Plate **9227/516** + Finish + Hand



Style **9034**  
Dia = 2 9/16"



Shown in Satin Bronze (**SB**)  
Near Actual Size



Passage Trim Set **9034/521** + Finish  
 Dummy Set **9034/522** + Finish  
 Trim w/Passage S Plate **9034/523** + Finish + Hand  
 Trim/Passage Mortise/S Plate **9034/524** + Finish + Hand  
 Trim/Privacy S Plate **9034/525** + Finish + Hand  
 Trim/Privacy Mortise/S Plate **9034/526** + Finish + Hand

Passage Trim Single **9034/511** + Finish  
 Dummy Single **9034/512** + Finish  
 Trim/Passage S Plate **9034/513** + Finish + Hand  
 Trim/Passage Mortise/S Plate **9034/514** + Finish + Hand  
 Trim/Privacy S Plate **9034/515** + Finish + Hand  
 Trim/Privacy Mortise/S Plate **9034/516** + Finish + Hand



Passage Trim Single **9223/511** + Finish  
Dummy Single **9223/512** + Finish  
Trim w/ S Plate **9223/513** + Finish + Hand  
Trim/Mortise/S Plate **9223/514** + Finish + Hand

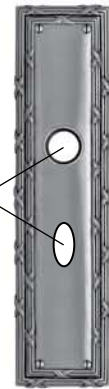
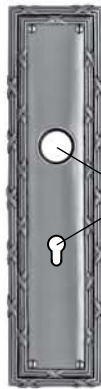

The Spacing is  
2 7/8" Center to Center  
or as Specified

Trim Keyhole **9223/711** + Finish  
Trim w/ S Plate **9223/713** + Finish + Hand  
Trim/Mortise/S Plate **9223/714** + Finish + Hand

Trim T/Turn **9223/811** + Finish  
Trim w/ S Plate **9223/813** + Finish + Hand  
Trim/Mortise/S Plate **9223/814** + Finish + Hand



Style **9017/91** + Finish  
1 3/8" X 11/16"  
OP = 3/4"  
Drawing (Photo Not Available)  
Near Actual Size

Additional T Turns Styles Available

Style **9223**  
11 1/4" X 2 13/16"  
Shown in Satin Bronze (**SB**)  
Width Near Actual Size  
A Section of the Piece is Excluded to Show the Bottom

PRODUCTS AT OR NEAR ACTUAL SIZE



Passage Trim Single **9360/511** + Finish  
Dummy Single **9360/512** + Finish  
Trim w/ S Plate **9360/513** + Finish + Hand  
Trim/Mortise/S Plate **9360/514** + Finish + Hand



Trim Keyhole **9360/711** + Finish  
Trim w/ S Plate **9360/713** + Finish + Hand  
Trim/Mortise/S Plate **9360/714** + Finish + Hand



Trim T/Turn **9360/811** + Finish  
Trim w/ S Plate **9360/813** + Finish + Hand  
Trim/Mortise/S Plate **9360/814** + Finish + Hand

The Spacing is  
2 7/8" Center to Center  
or as Specified



Style **9017/91** + Finish  
1 3/8" X 1 1/16"  
OP = 3/4"  
Drawing (Photo Not Available)  
Near Actual Size

Additional T Turns Styles Available

Style **9360**  
11 1/4" X 1 7/8"  
Custom Drill Only  
Shown in Satin White Bronze (**SW**)  
Width Near Actual Size  
A Section of the Piece is Excluded to Show the Bottom

AVAILABLE IN MULTIPPOINT

PRODUCTS AT OR NEAR ACTUAL SIZE



Style **8709** + Finish  
4 1/2" X 2"  
Pocket Door



Shown in Polished White Bronze (**PW**)  
Near Actual Size

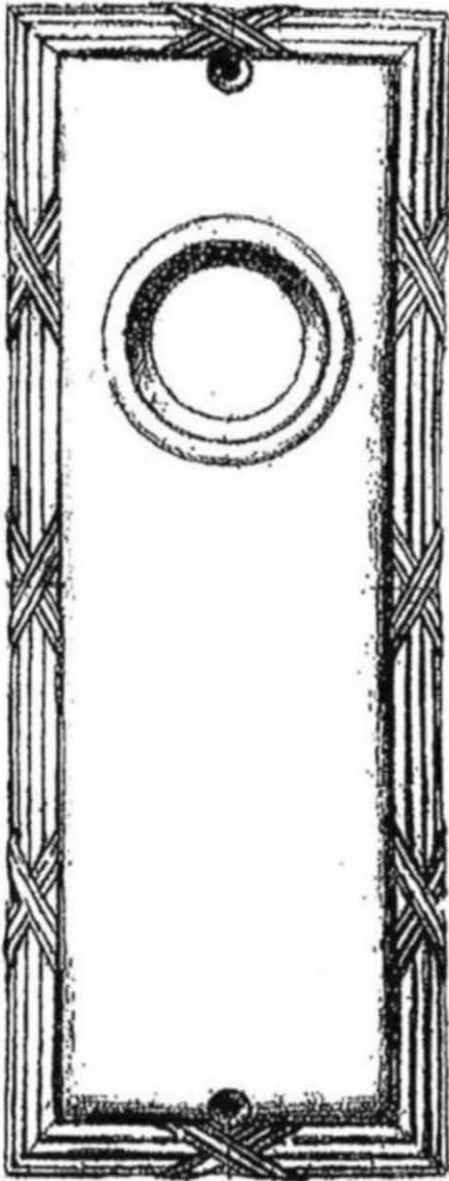

#9015  
6 1/16" x 2 5/16"  
custom drill only

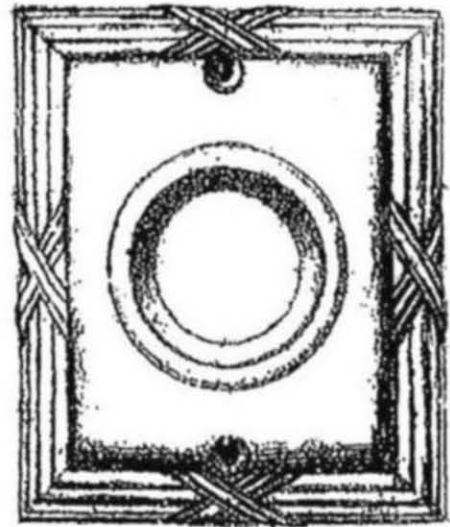

#9227  
2 9/16" x 2 5/16"  
custom drill only

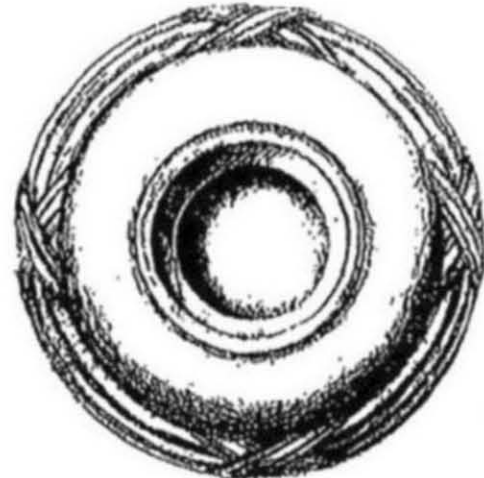

#9034  
dia = 2 9/16"

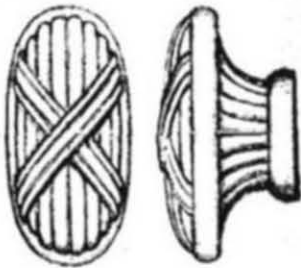

#9017/91  
1 3/8" x 11/16"  
OP = 3/4"

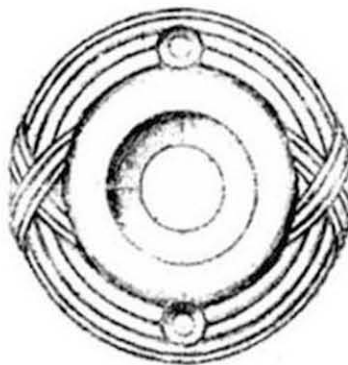

#9017/81  
dia = 1 7/8"



#9017/71  
dia = 1 5/8"

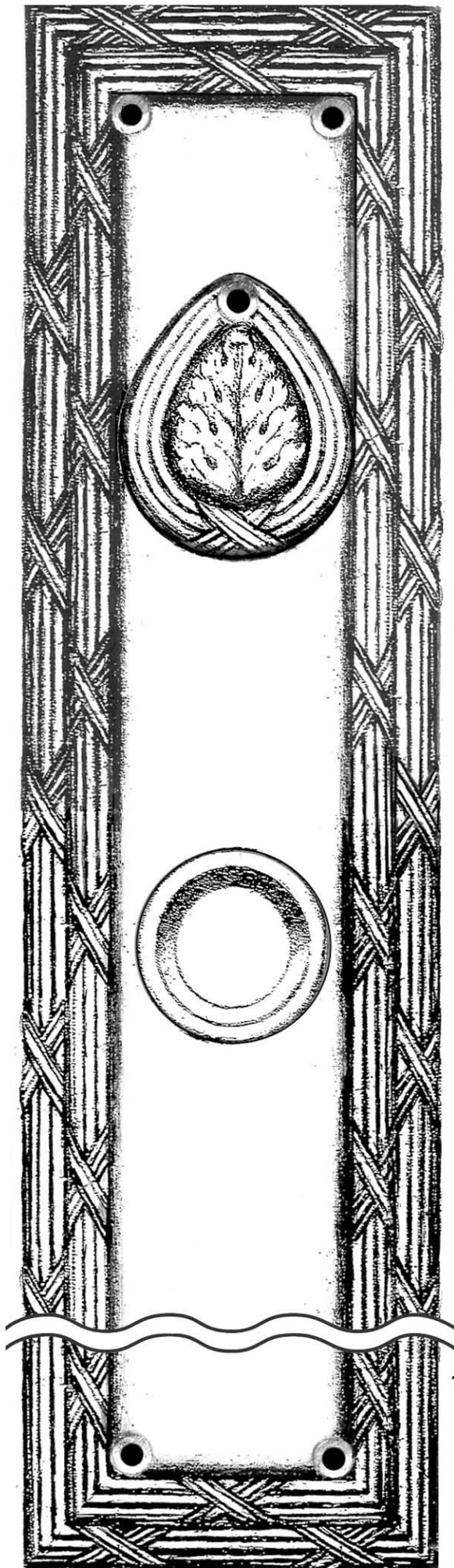

#9426\*  
10 15/16" x 2 3/4"  
ENTRY

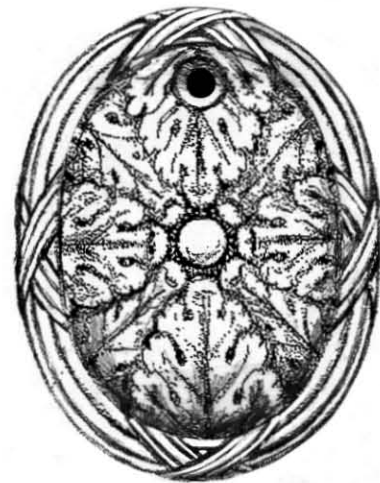

#9453\*  
2 5/8" x 1 15/16"  
ENTRY

#9360  
10 15/16" x 1 3/4"  
MULTIPOINT

